

NANO[®] CONNECT

USER MANUAL

7.0" Connected Smart Monitor



Connecting your drive.

NC-700

CONTENTS

1.0	INTRODUCTION	6
2.0	PACKAGE CONTENTS	6
3.0	PRODUCT OVERVIEW	7
4.0	MICRO SD CARD INSTALLATION	8
5.0	PRODUCT INSTALLATION	9
5.1	WINDSCREEN SUCTION MOUNT	9
5.2	AIR-CON VENT MOUNT	11
6.0	POWER CONNECTION	12
6.1	AUTO POWER ON/OFF	12
7.0	HOME SCREEN	13
7.1	APPLE CARPLAY	14
7.1.1	IPHONE SET-UP	15
7.2	Android Auto™	16
8.0	ANDROID AUTO™ SET UP	17
9.0	AUDIO OUTPUT SET UP	19
10.0	AUX SET UP	23
11.0	SPEAKER SET UP	25

12.0	MICRO SD CARD MEDIA FILE SET UP.....	26
13.0	REVERSING CAMERA CALIBRATION	27
14.0	SETTINGS.....	28
15.0	BASIC SET UP.....	29
16.0	TROUBLESHOOTING.....	29
17.0	MORE INFORMATION ON CARPLAY:.....	32
18.0	ADDITIONAL EXPLANATION.....	33
19.0	WARRANTY	34
20.0	NOTES	41

CAUTIONS

- Please ensure you are using your Smart Monitor within your country's road laws.
- Please make sure you are familiar with your local road legislation before use.
- The time and date need to be set before you start using the product.
- Please drive according to the actual conditions on the road.
- The system is for non-commercial use only, within the limits permitted by the relevant laws.
- Avoid using this product in the vicinity of any devices that emit radio interference, such as microwave ovens.
- Please note that it is normal for this product to get warm during use.
- Please ensure you maintain your focus on the road and not on the monitor while driving.
- Always power this product using the supplied charger.
- Never dismantle this product.
- Do not dispose of this product in fire.
- Disposal of this product should observe local regulations.

1.0 INTRODUCTION

Thank you for purchasing a NanoConnect NC-700 Smart Monitor. This product enables your smartphone to be seamlessly connected via Bluetooth and Wi-Fi for hands-free operation while driving.

Please read through these instructions before attempting to install this product. For the latest manual and product updates, please visit your relevant website:

www.nanocamplus.com.au

www.nanocamplus.co.nz

2.0 PACKAGE CONTENTS

1. Smart 7.0" Monitor x1
2. 12/24V Power Adaptor x1
3. AUX Cable x1
4. User Manual x1
5. Quick Start Guide x1
6. Dual Purpose Suction Mount x1
7. Air-Con Vent Mount x1

3.0 PRODUCT OVERVIEW

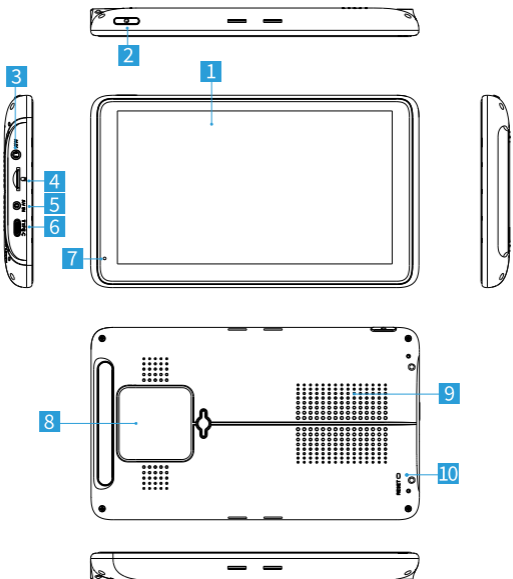

1. **Display screen**
2. **Power button:** Long press to power On/Off.
Short press to turn On/Off display.
3. **AUX input**
4. **Micro SD card slot** (SD Card not included)
5. **Rear Camera input** (Rear Camera Sold separately)
6. **Type-C connector** (for power supply)
7. **Microphone**
8. **Suction/Air-con vent mount**
9. **Speaker grille**
10. **Reset button:** Press this button to restart the device. (All pre-saved information will be lost).

4.0 MICRO SD CARD INSTALLATION

Please insert the memory card into the Micro SD Card slot with the chip contact surface facing down. Insert until you hear a click.

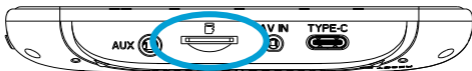

5.0 PRODUCT INSTALLATION

There are two mounting options available for installation:

1. Windscreen suction mount
2. Air-Con vent mount

5.1 WINDSCREEN SUCTION MOUNT

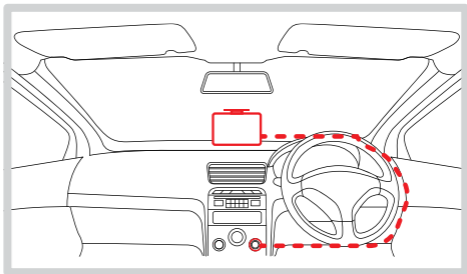

FIGURE: 1

- Insert the mount at the back of the NC-700.
- Clean windscreen area where the suction mount is to be mounted.
- Unlock the mount.
- Press the suction mount onto the windscreen

and lock it.

1. Clean the windscreen area where the suction mount is to be mounted.
2. Pull the suction cup lever up to release suction.
3. Press the suction mount on the windscreen and lock it by pressing the suction cup lever down until it snaps into place.
4. Fit the NC-700 onto the suction mount.

5.2 AIR-CON VENT MOUNT

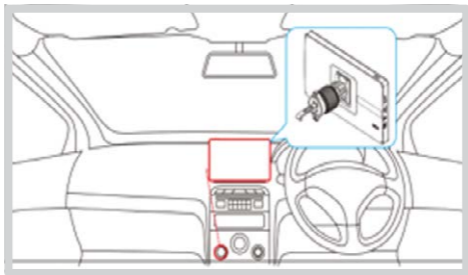

FIGURE: 2

- Choose area of air-con vent where the device is to be installed, then insert the mount hook into the air grille so it holds the grille piece. Turn the knob until it's firmly secured.
- Lock the NC-700 monitor into the mount buckle.
- Adjust the knob behind screen to tighten up the monitor with the mount.

CAUTION

Please ensure vent is closed as much as possible to limit hot/cold air blowing directly on the NC-700.

MOUNTING NOTES

- Please use only the included charging cable to power the Smart Monitor. Other cables may not work or may damage the product.

6.0 POWER CONNECTION

- Only use the supplied 12/24V power adaptor to power the NC-700.
- Once the NC-700 is securely installed on the windscreen or dashboard, plug the 12/24V power adaptor cable into the vehicle's 12/24V power port.
- Run the cable along the vehicle's dashboard and plug the Type-C connector into the NC- 700. (See Figure 1 or Figure 2).

6.1 AUTO POWER ON/OFF

When the NC-700 is correctly installed and connected to the 12/24V power port, it will automatically power up when the vehicle ignition is turned on.

NOTE:

- The NC-700 is designed to be powered only by the supplied DC power plug. Its internal battery is NOT designed for primary use.

7.0 HOME SCREEN



1. **Apple CarPlay™:** Touch for instructions to connect with iPhone.
2. **Android Auto™:** Touch for instructions to connect with Android phones.
3. **Rear Camera:** (Sold separately).
4. **Volume Button:** Touch to adjust volume.
5. **Brightness Button:** Touch to adjust screen brightness.
6. **Micro SD** card content
7. **Do Not Disturb Mode:** Touch to enable auto-reject of incoming calls.

8. **Audio Output:** Touch to change the sound output via Bluetooth, FM , AUX, or built-in speaker.
9. **Dark Mode:** Change background to Dark.
10. **Light Mode:** Change background to Bright.
11. **Display Button:** Touch to turn off screen, touch anywhere on screen again to turn on.
12. **Settings:** Touch to open Settings Menu.

7.1 APPLE CARPLAY

FIRST-TIME CONNECTION

Touch the Apply CarPlay™ icon to show the connection instructions. After first connection, it will show 'Connected' and display the Apple CarPlay™ menu.

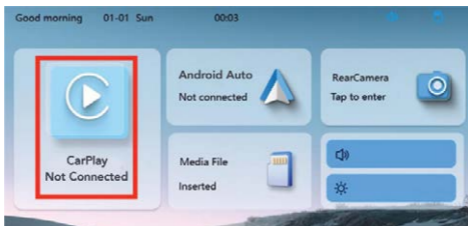

7.1.1 IPHONE SET-UP

- Please turn on Bluetooth and Wi-Fi on your iPhone.
- Pair your iPhone with the Smart Monitor by following below points.
- Find the Bluetooth name 'NC-700_XXXX' in the Bluetooth list, click to pair. (If PIN CODE IS PROMPTED, please input 0000).
- After successful Bluetooth pairing, Wi-Fi will automatically connect between the NC-700 and your iPhone.
- Allow Contacts and Favorites Sync will pop up on your phone, please touch Allow.
- Use CarPlay™ with 'NC-700' will pop up on your phone, please click Use CarPlay™.
- NC-700 and your iPhone will pair automatically each time the NC-700 is powered on when your iPhone is in close proximity.

NOTE:

- First-time connection will take slightly longer.
- Only compatible with iOS13.0 or higher.

Press Exit to return to the main screen. When this screen is powered on, it will automatically connect to the last connected phone.



7.2 ANDROID AUTO™

FIRST-TIME CONNECTION

Touch the Android Auto™ icon to show the connecting instructions. After first connection, it will show Connected and display the Android Auto™ menu.

8.0 ANDROID AUTO™ SET UP



HOW TO SET UP:

Touch the Android Auto™ icon.

Turn on the Wi-Fi and Bluetooth on the mobile phone; tap 'Pair New Device' (in Bluetooth settings) on your phone and find the Bluetooth name 'NC-700_XXXX' in the Bluetooth list, click to pair. (Try pin code 0000 if needed.)

Pair with 'NC-700_XXXX' will pop up on your phone, please click 'Pair'.

Allow access to messages will pop up on your phone, please click 'Allow'; afterwards it will automatically enter Android Auto™ interface.

From now on, connection between the NC-700 and your Android phone will be automatic each time the NC-700 is powered on when your phone is within close proximity.

Press Exit to return to the main screen.

NOTE:

- First-time connection will take slightly longer.
- Only compatible with Android 11.0 or higher.

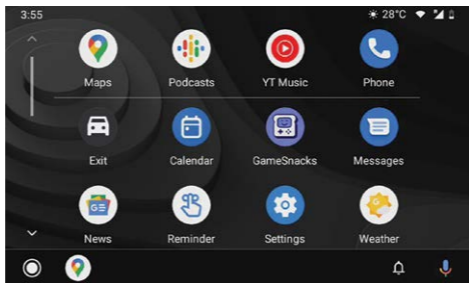

9.0 AUDIO OUTPUT SET UP

Default sound output is set from the device's in-built speaker. To improve the sound experience, it's recommended to change the sound output to Car Audio via Bluetooth or FM or AUX.

Car Audio is recommended.

CAR AUDIO

How to connect to car audio via Bluetooth

1. Touch icon 1
2. Touch icon 2
3. Touch icon 3
4. Touch the button on icon 4 to turn On/Off



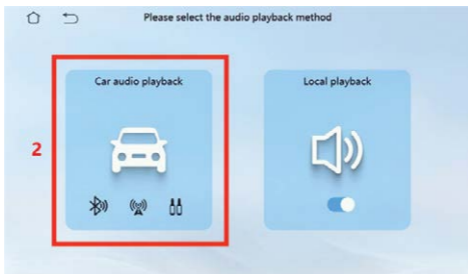

FM TRANSMITTER SET UP

1. Touch icon 1.
2. Touch icon 2.
3. Touch icon on the menu bar.
4. Touch icon 4 to turn On/Off.

The FM Transmitter can be used to transmit audio from the NC-700 to your vehicle's stereo speakers.

When you turn on the FM Transmitter, the NC-700 will be muted. You will have to match the frequency of the NC-700 to a free frequency channel on the vehicle's head unit.



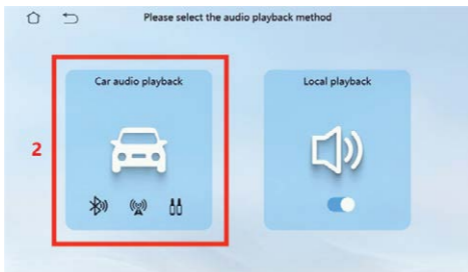

10.0 AUX SET UP

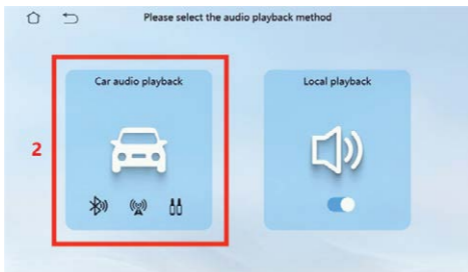

1. Touch icon 1.
2. Touch icon 2.
3. Touch icon 3.
4. Touch icon 4 to turn On/Off.



If your device is connected via an auxiliary cable to the AUX port of your vehicle, select AUX to play audio through the car stereo speakers.

11.0 SPEAKER SET UP

If you want to use the NC-700's built-in speaker, follow steps below:

1. Touch icon 1.
2. Touch the button in icon 2 to turn On/Off.



12.0 MICRO SD CARD MEDIA FILE SET UP

The MICRO SD card can be used to store movies and music, which can be played once the card is inserted into the slot. Please use MICRO SD cards from major brands such as SanDisk, Kingston, Toshiba, and Samsung.

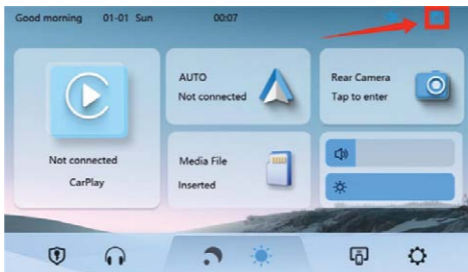

The speed certification must be at least Class 10. Once the MICRO SD card is fitted correctly, there'll will be a small card image shown on the upper right corner. Click Media File to get access to Music, Video and Images on your MICRO SD card.

13.0 REVERSING CAMERA CALIBRATION

After connecting the camera (sold separately) successfully, please follow below steps: tap to change image to mirror or non-mirror, the change will be effective after you next power on.

⌘ Flip the image upside down.

⏮⏭ Flip the image left to right.

⏮⏭⌘ Flip the image left to right and upside down.

⏮⏭ Will show original image without the mirror effect.

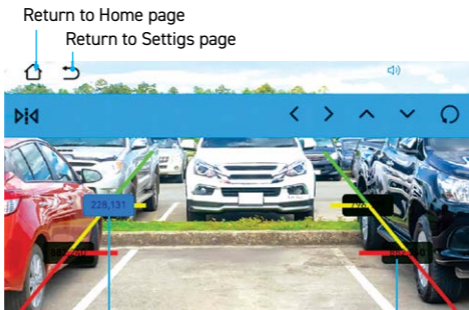

1. Park car with an empty parking space behind you.
2. There are four points on the screen where guidelines intersect, two red, two yellow.

3. Tap to select the intersection points, and align them with the perimeter lines of the actual space behind you (start with the rearmost line, aligning with the rearmost edge of the parking space).
4. Stop when screen's guidelines are aligned with actual space. Set up will be applied when you next power on.

14.0 SETTINGS

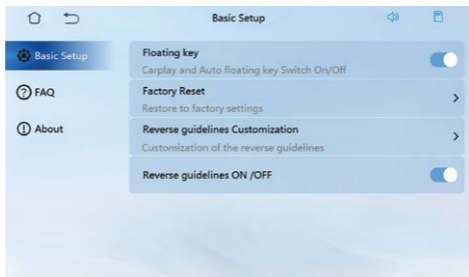

Click the right icon on the menu bar.

15.0 BASIC SET UP

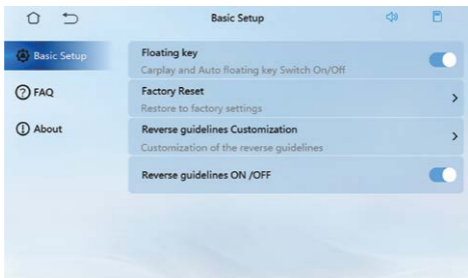

16.0 TROUBLESHOOTING

PROBLEM	SOLUTION
Unable to turn on CarPlay™ Screen.	Check if DC head of the cigarette lighter power cord is damaged or aging.
	Ensure power plug is not disconnected or burned out.
Touch screen is not responding.	Reset the unit to factory mode and try again.
Machine getting overheated after long usage.	The normal operating temperature range is -4 to 149°F (-20°C to 65°C). Disconnect the power supply to lower the temperature if it exceeds 149°F.

PROBLEM	SOLUTION
<p>CarPlay™ cannot connect.</p>	<p>The first connection may take longer. Only iPhone supports CarPlay™.</p> <p>Ensure WiFi and Bluetooth functions on the phone are working.</p> <p>In iPhone Settings, go to General > CarPlay™, delete all records, and reconnect.</p> <p>Restart the iPhone and try reconnecting.</p> <p>Restore screen's Factory Settings by going to home screen: Setting>Basic Setup> Restore Factory Setting.</p>
<p>Android Auto™ cannot connect.</p>	<p>Only Android phones are supported.</p> <p>Update Android system and related applications to the latest version.</p> <p>Disconnect any VPN on the mobile phone if applicable.</p> <p>Ensure WiFi and Bluetooth functions on mobile phone are working.</p> <p>Restart the Android phone and reconnect.</p> <p>Restore screen's Factory Settings by going to home screen: Setting>Basic Setup> Restore Factory Setting.</p>

PROBLEM	SOLUTION
Car Stereo has no sound.	Check if volume is set to zero or if radio is muted.
	NOTE: FM Transmitter function cannot work normally if you do not use our original charger.
	The car stereo needs to be connected via Bluetooth, FM transmission or AUX cable. Check if the corresponding button is turned on.
When connecting CarPlay™ or Android Auto™, Bluetooth of device cannot be seen or cannot be connected.	<p>Check if another phone is connected or attempting to auto-connect to the CarPlay™ screen. Disconnect Bluetooth/WiFi from other phones, then connect the preferred device again.</p> <p>Restart the screen by reconnecting the car charger. If still not working, restore screen Factory Setting. Go to home screen interface: Setting>Basic Setup> Restore Factory Setting.</p>
Screen's speaker not loud enough.	Check Car Stereo for more information.

PROBLEM	SOLUTION
Screen gets stuck.	If the unit crashes and the screen gets stuck, cut off the power and turn on screen again.
The screen cannot be turned off when car's turned off.	Some cars provide power to the cigarette lighter even after turning off the key. Manually turn off the CarPlay™ screen power button on top of the screen.

17.0 MORE INFORMATION ON CARPLAY:

Wireless CarPlay™ supported phone models should be running operating systems above iOS 9. The following phones are compatible with CarPlay™:

iPhone 15, iPhone 15 Plus, iPhone 15 Pro, iPhone 15 Pro-f, iPhone 14, iPhone 14 Plus, iPhone 14 Pro, iPhone 14 Pro-Max, iPhone 13 Pro, iPhone 13 Pro-Max, iPhone 13, iPhone 13 mini, iPhone 12 Pro, iPhone 12, iPhone 12 mini, iPhone 11 Pro, iPhone 11 Pro Max, iPhone 11, iPhone XS, iPhone XS-Max, iPhone XR, iPhone X, iPhone 8, iPhone 8 Plus, iPhone 7, iPhone 7 Plus, iPhone 6s, iPhone 6s-Plus, iPhone 6, iPhone 6Plus, iPhone SE. iPhone 5s, iPhone 5c, iPhone 5.

NOTE: Currently, lower versions of the iOS system may not be able to use CarPlay™. If there are some compatibility issues with your phone's CarPlay™, please try upgrading the iOS system.

18.0 ADDITIONAL EXPLANATION

CarPlay™ principles of use:

CarPlay™ uses Bluetooth to connect between the phone and the vehicle, then it switches to WiFi for actual functionality by default.

When the car is powered on, the smart monitor will try to automatically connect to the last connected phone.

Please pay attention to the following:

When using CarPlay™/Android Auto™ function, the phone's WiFi will be occupied by the CarPlay™ Screen. You need to manually disconnect other WiFi to keep the wireless CarPlay™/Android Auto™ in use.

The auto-connection function of the car stereo requires you to keep the WiFi and Bluetooth of the mobile phone available.

In addition, please set the WiFi network of the car stereo to 'Auto-Join'.

After pairing, the car stereo disconnects Bluetooth, which might cause your phone to connect to other devices and disrupt the car stereo's mic input or audio playback. To fix this,

manually disconnect your phone from other Bluetooth devices or turn off Bluetooth. Once paired, the car stereo uses WiFi to function, so Bluetooth can be turned off. However, Bluetooth needs to be on for the next pairing.

Note: You need to first turn off Bluetooth and then turn off WiFi to disconnect. If you only turn off WiFi, the car stereo will keep trying to reconnect.

19.0 WARRANTY

WARRANTY TERMS AND CONDITIONS

Our goods come with guarantees that cannot be excluded under the Australian Consumer Law. You are entitled to a replacement or refund for a major failure and for compensation for any other reasonably foreseeable loss or damage.

You are also entitled to have the goods repaired or replaced if the goods fail to be of acceptable quality and the failure does not amount to a major failure.

This warranty is provided in addition to your rights under the Australian Consumer Law.

Directed Electronics Australia Pty Ltd (Directed Electronics) warrants that this product is free from defects in material and workmanship for a period

of 12 months from the date of purchase or for the period stated on the packaging. This warranty is only valid where you have used the product in accordance with any recommendations or instructions provided by Directed Electronics.

This warranty excludes defects resulting from alterations of the product, accident, misuse, abuse or neglect. In order to claim the warranty, you must return the product to the retailer from which it was purchased or if that retailer is part of a National network, a store within that chain, along with satisfactory proof of purchase. The retailer will then return the goods to Directed Electronics.

Directed Electronics will repair, replace or refurbish the product at its discretion. The retailer will contact you when the product is ready for collection. All costs involved in claiming this warranty, including the cost of the retailer sending the product to Directed Electronics, will be borne by you.

Directed Electronics Address: 115-119 Link Road
Melbourne Airport, 3045 Victoria. Australia

Ph: +61 03 8331 4800

Email: service@NanoConnect.com.au

To view the complete NanoConnect range or for details on how to contact us, please visit our websites:

www.nanocamplus.com.au

www.nanocamplus.co.nz



**Scan QR code
for assistance.**

INDEMNITY

You agree to defend, indemnify and hold harmless NanoConnect and its subsidiaries and affiliates from and against any and all claims, proceedings, injuries, liabilities, losses, costs and expenses (including reasonable legal fees), including but not limited to, claims alleging negligence, invasion of privacy, copyright infringement and/or trademark infringement against NanoConnect and its subsidiaries and affiliates, relating to or arising out of your breach of any provision of these terms, your misuse of NanoConnect products or its services, or your unauthorised modification or alteration of products or software.

WARRANTY AND WARRANTY DISCLAIMER

NanoConnect has a limited warranty on whereby NanoConnect warrants to you and only to you that NanoConnect products will be free from defects in materials and workmanship for one (1) year from the date of your purchase (unless a longer warranty period is required by law).

The specifics of this NanoConnect limited warranty are covered in this manual.

To the extent possible under governing law, other than the above product warranty for the NanoConnect product you understand and agree that the NanoConnect products and services are provided on an "as is" and "as available" basis.

NanoConnect makes no warranty that the NanoConnect products and services will meet your requirements or that use of the NanoConnect products and services will be uninterrupted, timely, secure or error-free. Nor NanoConnect make any warranty as to the accuracy or reliability of any information obtained through the NanoConnect (including third party content), that any defects in the NanoConnect will be corrected or that the NanoConnect products or services will be compatible with any other specific hardware or service. Further, NanoConnect does not warrant that the NanoConnect or the NanoConnect servers that provide you with data and content are free of viruses or other harmful components.

NanoConnect also assumes no responsibility for and shall not be liable for any damages caused by viruses that may infect your NanoConnect.

In the event of any loss, damage or injury, you will not look to NanoConnect to compensate you or anyone else. You release and waive for yourself and your insurer all subrogation and other rights to recover against NanoConnect arising as a result of the payment of any claim for loss, damage or injury.

NanoConnect equipment and services do not cause and cannot eliminate occurrences of certain events, including, and NanoConnect makes no guarantee or warranty, including any implied warranty of merchantability or fitness for a particular purpose, that the NanoConnect equipment and services provided will detect or avert such incidents or their consequences.

NanoConnect does not undertake any risk that you or property, or the person or property of others, may be subject to injury or loss if such an event occurs. The allocation of such risk remains with you, not NanoConnect.

Other than the above product warranty for the NanoConnect, its suppliers disclaim all warranties of any kind, whether express, implied, or statutory, regarding NanoConnect products and services, including any implied warranty of title, merchantability, fitness for a particular purpose, or noninfringement of third party rights.

Because some jurisdictions do not permit the exclusion of implied warranties, the last sentence of this section may not apply to you. NanoConnect hereby further expressly disclaims all liability for any claims for service failures that are due to normal product wear, product misuse, abuse, product modification, improper product selection or your non-compliance with all applicable federal, state or local laws.

This warranty and warranty disclaimer give you specific legal rights, and you may have other rights that vary by state, province, or country. Other than as permitted by law, NanoConnect does not exclude, limit or suspend other rights you have, including those that may arise from the nonconformity of a sales contract.

For a full understanding of your rights you should consult the laws of your state, province, or country. For our Australian customers: Please note that this warranty is in addition to any statutory rights in Australia in relation to your goods which, pursuant to the Australian Consumer Law, cannot be excluded.

LIMITATIONS OF NANOCONNECT LIABILITY

Under no circumstances will NanoConnect be liable in any way for any content, including, but not limited to, the loss of content, any errors or omissions in any content, or any loss or damage of any kind incurred in connection with use of or exposure to any content posted, emailed, accessed, transmitted, or otherwise made available via NanoConnect.

NanoConnect liability for damages, especially for breach of duty or obligation, delay in performance, non-performance, or malperformance shall be precluded, except when these are due to negligent breaches of any significant contractual duty or obligation on the part of NanoConnect. Any liability for negligence is limited to direct losses usually and typically foreseeable in such case.

Should the claim for damages be based on wilful or grossly negligent breach of contractual duty or obligation on the part of NanoConnect, the preclusion and limitation of liability mentioned in the preceding sentences will not apply. The preceding preclusion and limitation of liability will also not apply to claims for damages arising out of loss of life, bodily injury or health impacts for which NanoConnect may be liable, or for non-contractual liability.

Some states and countries do not allow the exclusion or limitation of incidental or consequential damages, so the above limitation or exclusion may not apply to you. Additionally, this provision is not intended to limit NanoConnect's liability in the event of NanoConnect's wilful or intentional misconduct.

20.0 NOTES

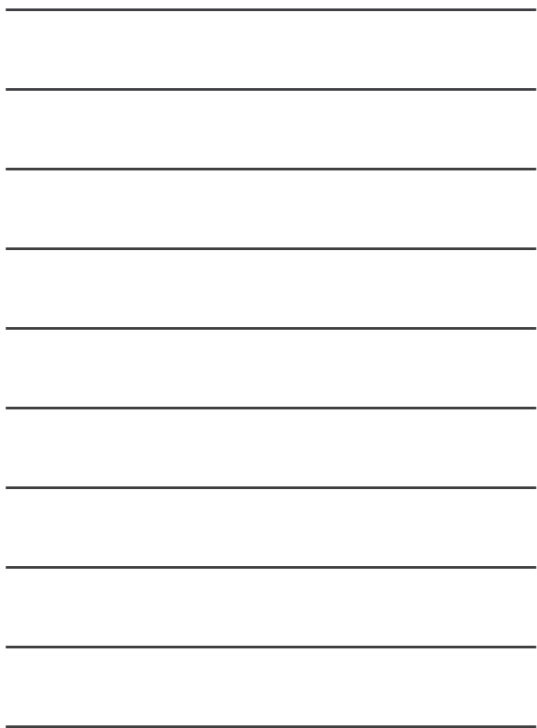

Connecting your drive.

www.nanocamplus.com.au | www.nanocamplus.co.nz



R-NZ

NANO CONNECT

ANOTHER
DIRECTED
BRAND

DIRECTED
AUSTRALIA & NZ

All Images, Information and Content are Copyright © 2024
Directed Electronics Australia Pty Ltd. All Rights Reserved.

www.directed.com.au
www.directed.co.nz