

NANO
CAM+
PLUS

NCP-DVRFHD

USER MANUAL

FULL-HD DASH CAM DVR

WITH 3" LCD & MOTION
DETECTION



FULLHD
1080p

RESOLUTION



120° FIELD OF VIEW



G-SENSOR



3" LCD SCREEN

CONTENTS

Caution	6
Battery Warning	6
Notes on Installation.....	7
1. INTRODUCTION.....	7
1.1 Features.....	8
1.2 Package Contents	8
1.3 Product Overview.....	9
2. GETTING STARTED	9
Inserting Memory Card.....	9
To remove the memory Card.....	10
2.1 Installing the Car DVR	10
Adjust the device position	10
Connecting to Power	11
2.2 Powering the Car DVR On / Off.....	12
Auto Power On/Off	12
Manual Power On/Off and Reset.....	12

Manual Power On	12
Power Off	12
Reset the Device.....	12
2.3 Playing back video on a PC.....	13
2.4 Initial Settings.....	13
Formatting the Inserted Micro SD Card	13
Set Date / Time.....	14
2.5 Using the Car DVR.....	15
Recording Video	15
Locked Recording	15
Video Mode	16
2.6 Video Menu.....	17
Resolution.....	17
Loop Recording	18
Exposure	19
Motion Detection	20
Recording Audio	20
Date Stamp	21

G Sensor (Gravity Sensing)	22
Settings Menu.....	23
Park Mode.....	23
Set Date / Time.....	24
Key Beeps	25
3. PHOTO MODE.....	26
3.1 Photo Menu	26
Resolution.....	26
Sequence	27
Quality	27
Sharpness	28
White Balance.....	29
ISO	30
Exposure	31
Quick Review.....	32
Date Stamp	33
Formatting the Inserted Micro SD Card	34

3.2 Playback Screen	34
3.3 Playback Menu	35
Deleting Photos and Videos	35
Locking and Unlocking Photos and Videos	36
4. MENU TABLES	37
Menu Tables Continued	38
5. WARRANTY TERMS & CONDITIONS.....	39
6. NOTES	40

CAUTION

- Ensure you are using your Car DVR within your countries' road laws. Please make sure you are familiar with your local road legislation before use.
- Avoid leaving your Car DVR in direct sunlight for extended periods of time in an unventilated space. Please set time and date before you use this device to record.
- The notifications given by the Car DVR are suggestions only, please drive to the actual conditions.
- The system is to be used only for non-commercial use, within the limits permitted by the relevant laws
- Avoid using the Car DVR in the vicinity of any devices that emit radio interference (eg. Microwave Ovens).
- It is considered normal operation for the Car DVR to get warm during use.

BATTERY WARNING

- Always charge the Car DVR using the provided charger. Improper charging of the Car DVR may result in failure of the internal battery.
- Never dismantle the Car DVR or expose the internal battery.
- Do not dispose of the Car DVR in fire.
- Dispose of the Car DVR observing local regulations being mindful of the internal battery.
- Do not attempt to replace or expose the internal battery.

NOTES ON INSTALLATION

1. It is advised that the Car DVR is installed near the rear view mirror, at the top centre of the windshield for optimal operation.
2. Make sure that the lens is within the range of the windscreen wiper to ensure a clear view when it rains.
3. Do not touch the lens with your fingers. Finger prints left on the lens will result in unclear videos or photos. If photos or videos are blurred, please clean the lens gently with a microfibre cloth.
4. Only use the included charging cable to power the Car DVR.

1. INTRODUCTION

Thank you for purchasing a NanoCam Plus Car DVR. We are certain that our product will give you trouble free operation while providing you with a safety feature that enhances your driving experience. Our products, like most after-market safety enhanced devices, are designed to assist and aid the driver, not to replace the manual function of the person operating the vehicle. Please read through these instructions before attempting to install this product.

For the latest manual and product updates, please visit our website at www.nanocamplus.com.au or www.nanocamplus.co.nz

1.1 FEATURES

- Recording full high definition 1080P footage at 30 frames per second.
- 3" colour screen
- 120° wide angle lens
- Emergency recording saves your footage when an impact is detected
- Supports Micro SD cards, class 6 and above up to 32GB

1.2 PACKAGE CONTENTS



1. Dash Camera
2. Suction Mount
3. Charging Cable

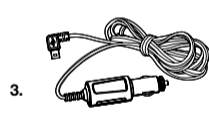

1.3 PRODUCT OVERVIEW

1	Mini USB Power Socket	7	🔒 Lock Recording Button
2	Micro SD Card Slot	8	🔄 Mode Button
3	▲ Up Button	9	🔘 Power Button
4	☰ Menu Button	10	Lens
5	▼ Down Button	11	Microphone
6	OK Rec/OK Button	12	Reset Button

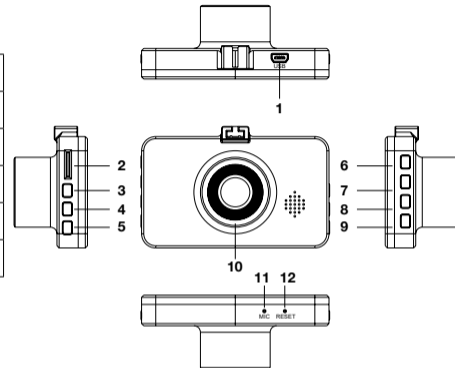

2. GETTING STARTED

INSERTING MEMORY CARD

With the Car DVR turned off and the screen facing towards you insert the memory card into the slot on the left side of the camera with the text on the Micro SD card facing away from you. Push the memory card in until a click is heard.

* Please note that a Micro SD card is NOT included and will need to be purchased separately.

When making your Micro SD card purchase please ensure that it is class 6 or above and no greater than 32GB in capacity.

Note:

- Do not remove or insert the memory card while the Car DVR is turned on as this may damage the memory card or corrupt the memory cards stored data.
- Please use a Class 6 or higher rated micro SD card with a maximum capacity of 32GB.
- Please format the Micro SD card before the initial use.
- When removing the memory card, be careful as the card may eject quickly.

TO REMOVE THE MEMORY CARD

Ensure that the Car DVR is powered off, then push the memory card until a click is heard and then release the card to eject.

2.1 INSTALLING THE CAR DVR

1. Remove the protective stickers from the Car DVR and the Suction Mount.
2. Insert the plastic mount end of the Suction Mount into the camera's mount slot slide the mount back until the camera is firmly attached.
3. Press the mount base firmly against the windscreen with the suction mount switch in the down position.
4. Secure the mount by flipping the switch up while still holding the base against the windscreen.

ADJUST THE DEVICE POSITION

1. Loosen the knob on the mounting bracket, and adjust the vertical and horizontal angle of the camera.
2. Tighten the knob to lock the position of the camera.

CONNECTING TO POWER

Only use the included charger to power and charge the Car DVR.

1. Once the Car DVR is securely installed on your vehicle's windscreen, plug the 12v charger into your vehicle's cigarette lighter.
2. Run the cable along your vehicle's console and windscreen and plug the USB Micro plug into the Car DVR.

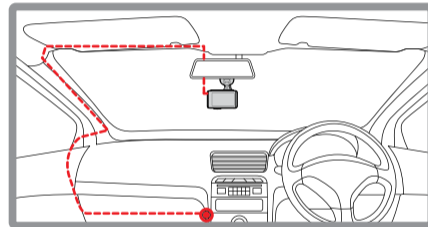
**Note:**

- It is recommended that the Car DVR is installed behind your vehicle's rear view mirror.
- Make sure that the camera view is not obstructed by any window tint or any other objects.
- When removing the suction mount be sure to release the suction mount by switching the suction latch to the down position.
- It is strongly recommend that the camera is installed so that it does not encroach further than the top 10% of your windscreen to avoid any potential road restrictions.

2.2 POWERING THE CAR DVR ON / OFF

AUTO POWER ON/OFF

When the Car DVR is correctly installed and connected to your vehicle's 12v power supply, the Car DVR will automatically power up and start recording when the vehicle accessories are activated.

MANUAL POWER ON/OFF AND RESET

MANUAL POWER ON

Hold the  Power button on the top of the camera until the NanoCam Plus start up screen appears.

POWER OFF

Make sure that recording has been stopped and then press the Power button on the top of the car DVR. After powering down the device please wait for 10 seconds before turning the Car DVR back on.

RESET THE DEVICE

If the Car DVR does not function normally, try restarting the car DVR. To restart the car DVR, with a flattened paper clip press the small button in the middle of the underside of the Car DVR.

2.3 PLAYING BACK VIDEO ON A PC





To playback video files on your PC it is recommended to connect the Micro SD card (not included) directly to your PC using either a USB Micro SD card reader (not included) or if your PC has a SD card slot, a Micro SD/SD Card converter (not included). Once the Micro SD card is connected it should appear as a removable storage device. It is recommended that you transfer video files that you want to playback to a file on your computer before attempting to playback. This will reduce any delay in playback.

2.4 INITIAL SETTINGS

Before using the Car DVR we recommend Formatting the Inserted Micro SD Card and setting the correct Time and Date.

FORMATTING THE INSERTED MICRO SD CARD

Formatting the Micro SD card will delete all information on the inserted Micro SD Card and prepare the card for use with the Car DVR.

1. Press the **OK** Rec/Ok Button to stop the Car DVR from recording.
2. Press the  Menu Button to enter the Video Menu.
3. Press the  Menu Button again to enter the Settings Menu.
4. Use the  Up and  Down Buttons to navigate the Settings Menu and highlight the Format setting and press **OK** Rec/Ok to select.
5. Select OK to confirm and press the **OK** Rec/Ok Button.

Note:

- Menus cannot be accessed while the camera is recording. Please stop the recording before attempting to access the menu.
- Formatting your Micro SD Card will delete all files from the card. Once these files have been deleted you will not be able to recover them.

SET DATE / TIME

Setting the Time and Date allows you to stamp your footage with the time as a reference.

1. Press the **OK** Rec/Ok Button to stop the Car DVR from recording.
2. Press the **≡** Menu Button to enter the Video Menu.
3. Press the **≡** Menu Button again to enter the Settings Menu.
4. Use the **▲** Up and **▼** Down Buttons to navigate the Settings Menu and highlight the Date/Time setting and press **OK** Rec/Ok to select.
5. Use the **▲** Up and **▼** Down Buttons to edit the selected digit and the **OK** Rec/Ok button to confirm and progress to the next digit. The final field sets the format that the date will be presented in.
6. To save and exit the time and date, press the **≡** Menu button.

Note:

- Menus cannot be accessed while the camera is recording. Please stop the recording before attempting to access the menu.
- Once the time and date is set it can be stamped onto your footage using the Date Stamp setting. Please see section Date Stamp for more details.

2.5 USING THE CAR DVR

RECORDING VIDEO

When the Car DVR is connected to your vehicle's 12v power supply, the Car DVR will automatically power up and begin recording when you start your vehicle. During the start up the buttons will be unresponsive and the camera will take a moment to begin recording. The Car DVR will automatically stop recording and shutdown when your vehicle is powered off.

Note:

- Because of how some vehicles are wired, the recording may continue when the engine is switched off. If this happens, please manually turn off the Car DVR or remove the car adapter from the cigarette lighter when not in use.
- The recording loop length can be configured to save a video file for every 1,2,3,5 or 10 minutes of recording. For information on how to adjust this setting please refer to the Loop Recording section of this manual.
- The device saves the recorded footage and photos on to the inserted Micro SD Card. If the memory card capacity is full, the oldest file in the memory card will be overwritten.

LOCKED RECORDING

Locked Recording saves the current video file and protects it from being overwritten. To manually start a Locked Recording follow the instructions below.

1. During recording push the **≡** Menu button.

Note:

- If the G Sensor (Gravity Sensing) function is enabled and a collision is detected, the device will automatically trigger the emergency recording and protect the current video file. Please refer to the section titled G Sensor (Gravity Sensing).
- The emergency recording file is created as a new file, which will be protected to avoid being overwritten by normal loop recording. If the inserted Micro SD Card fills up with Emergency Recording files the message "SD Card Full" will appear on the screen, the oldest emergency file will be automatically deleted when a new emergency recording file is created.

1	Video Mode	8	Recording Time
2	Loop Recording	9	Resolution
3	Exposure	10	Date
4	Recording Indicator	11	Time
5	Recording Lock	12	SD Card
6	Microphone/Mute Recording	13	Battery
7	Park Mode		

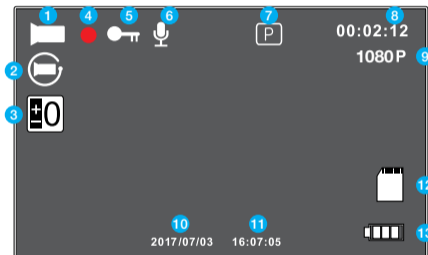
**VIDEO MODE**

When the Car DVR is powered up the video screen will start by default. In this screen recording will automatically start and can be stopped by pressing the **OK** (Rec/Ok) Button. To access the Video Menu, ensure that the Car DVR is not recording then press the **≡** Menu button.

2.6 VIDEO MENU**RESOLUTION**

Resolution sets the video quality. Higher resolution video will capture more detail and will also produce larger files. To change the recording resolution, please follow the instructions below.

1. Press the **OK** (Rec/Ok) Button to stop the Car DVR from recording.
2. Press the **≡** Button to enter the Video Menu.
3. Use the **▲** Up and **▼** Down Buttons to navigate the Settings Menu and highlight the Resolution setting and press **OK** (Rec/Ok) to select.
4. Use the **▲** Up and **▼** Down Buttons to highlight your required resolution, then press the **OK** (Rec/Ok) button to confirm your selection.

Note:

- Menus cannot be accessed while the camera is recording. Please stop the recording before attempting to access the menu.
- Higher resolution clips will create larger files which will fill the Micro SD Card faster.

LOOP RECORDING

Loop recording allows you to set the duration that the camera will record before creating a new clip. To set the clip length please follow the instructions below.

1. Press the **OK** (Rec/Ok) Button to stop the Car DVR from recording.
2. Press the **≡** Button to enter the Video Menu.
3. Use the **▲** Up and **▼** Down Buttons to navigate the Settings Menu and highlight the Loop Recording setting and press **OK** (Rec/Ok) to select.
4. Use the **▲** Up and **▼** Down Buttons to highlight your required Clip Length, then press the **OK** (Rec/Ok) button to confirm your selection.

Note:

- Menus cannot be accessed while the camera is recording. Please stop the recording before attempting to access the menu.
- Selecting the OFF option will create the longest possible clip, in most cases depending on the set resolution and other factors this will be limited to 10MB.
- To avoid filling the card quickly it is advised to use the 1 or 2 minute options.

EXPOSURE

Exposure is used to manually control the light sensitivity settings. To change the Exposure setting follow the instructions below.

1. Press the **OK** (Rec/Ok) Button to stop the Car DVR from recording.
2. Press the **≡** Button to enter the Video Menu.
3. Use the **▲** Up and **▼** Down Buttons to navigate the Settings Menu and highlight the Exposure setting and press **OK** OK button to select.
4. Use the **▲** Up and **▼** Down Buttons to highlight your required Exposure setting, then press the **OK** (Rec/Ok) button to confirm your selection.

Note:

- Menus cannot be accessed while the camera is recording. Please stop the recording before attempting to access the menu.

MOTION DETECTION

Motion Detection is used to pause recording when no motion is detected in front of the camera, and to start recording when motion is detected again. To activate the Motion Detection setting follow the instructions below.

1. Press the **OK** (Rec/Ok) Button to stop the Car DVR from recording.
2. Press the **≡** Button to enter the Video Menu.
3. Use the **▲** Up and **▼** Down Buttons to navigate the Settings Menu and highlight the Motion Detection setting and press **OK** (Rec/Ok) to select.
4. Use the **▲** Up and **▼** Down Buttons to highlight either OFF or ON, then press the **OK** (Rec/Ok) button to confirm your selection.

Note:

- Menus cannot be accessed while the camera is recording. Please stop the recording before attempting to access the menu.

RECORDING AUDIO

The Recording Audio setting allows you to mute the microphone during recording, or set it to record. To set your recording preferences, please follow the instructions below.

1. Press the **OK** (Rec/Ok) Button to stop the Car DVR from recording.
2. Press the **≡** Button to enter the Video Menu.
3. Use the **▲** Up and **▼** Down Buttons to navigate the Settings Menu and highlight the Recording Audio setting and press **OK** (Rec/Ok) to select.
4. Use the **▲** Up and **▼** Down Buttons to highlight either OFF or ON, then press the **OK** (Rec/Ok) button to confirm your selection.

Note:

- Menus cannot be accessed while the camera is recording. Please stop the recording before attempting to access the menu.

DATE STAMP

Date stamp will stamp the current date onto the footage for future reference. To set the date stamp please follow the instructions below.

1. Press the **OK** (Rec/Ok) Button to stop the Car DVR from recording.
2. Press the **≡** Button to enter the Video Menu.
3. Use the **▲** Up and **▼** Down Buttons to navigate the Settings Menu and highlight the Date Stamp setting and press **OK** (Rec/Ok) to select.
4. Use the **▲** Up and **▼** Down Buttons to highlight either OFF or ON, then press the **OK** (Rec/Ok) button to confirm your selection.

Note:

- Menus cannot be accessed while the camera is recording. Please stop the recording before attempting to access the menu.
- For date stamp to be correct the time and date must be set first. To set the time and date please see section Date/Time

G SENSOR (GRAVITY SENSING)

The G Sensor defines the required force needed to trigger emergency recording. Once Emergency recording is triggered the current recording will be saved and protected from being saved over by the normal loop recording. To set the required sensitivity please follow the instructions below.

1. Press the **OK** (Rec/Ok) Button to stop the Car DVR from recording.
2. Press the **≡** Button to enter the Video Menu.
3. Use the **▲** Up and **▼** Down Buttons to navigate the Settings Menu and highlight the Gravity Sensing setting and press **OK** (Rec/ Ok) to select.
4. Use the **▲** Up and **▼** Down Buttons to highlight either OFF or ON, then press the **OK** (Rec/Ok) button to confirm your selection.

Note:

- Menus cannot be accessed while the camera is recording. Please stop the recording before attempting to access the menu.
- If your memory card is filling up quickly you may need to lower the sensitivity of the G Sensor (Gravity Sensor) to decrease the number of triggers caused by normal driving.

SETTINGS MENU

The Settings menu is used to adjust the cameras Settings.

To Access the Settings menu, ensure that the camera is not recording and press the **≡** Menu Button to enter the Video Menu, then press the **≡** Menu Button again to enter the Settings menu.

PARK MODE

When activated, Park Mode will monitor the DVR's G Sensor after you have turned off your vehicle. If an impact is detected the DVR will power up and record a 60 second clip. To set Park Mode, follow the instructions below.

1. Ensure that the Car DVR is not recording.
2. Press the **≡** Menu Button to enter the Video Menu.
3. Press the **≡** Menu Button again to enter the Settings Menu.
4. Use the **▲** Up and **▼** Down Buttons to navigate the Settings Menu and highlight the Parking Mode setting and press **OK** (Rec/Ok) to select.
5. Use the **▲** Up and **▼** Down Buttons to highlight either OFF or ON, then press the **OK** (Rec/Ok) button to confirm your selection.

Note:

- Menus cannot be accessed while the camera is recording. Please stop the recording before attempting to access the menu.
- Park mode requires the DVR's internal battery to be fully charged.
- Park Mode is activated when an impact is detected and will record from that point onward.

SET DATE / TIME

Setting the Time and Date allows you to stamp your footage with the time as a reference.

1. Press the **OK** Rec/Ok Button to stop the Car DVR from recording.
2. Press the **≡** Menu Button to enter the Video Menu.
3. Press the **≡** Menu Button again to enter the Settings Menu.
4. Use the **▲** Up and **▼** Down Buttons to navigate the Settings Menu and highlight the Date/Time setting and press **OK** Rec/Ok to select.
5. Use the **▲** Up and **▼** Down buttons to edit the selected digit and the **OK** Rec/Ok button to confirm and progress to the next digit.
The final field sets the format that the date will be presented in.
6. To save and exit the time and date, press the **≡** Menu button.

Note:

- Menus cannot be accessed while the camera is recording. Please stop the recording before attempting to access the menu.
- Once the time and date is set it can be stamped onto your footage using the Date Stamp setting. Please see section Date Stamp for more details.

KEY BEEPS



The key beeps setting mutes the beep button that is emitted when a button on the Car DVR is pressed

1. Press the **OK** (Rec/Ok) Button to stop the Car DVR from recording.
2. Press the **≡** Menu Button to enter the Video Menu.
3. Press the **≡** Menu Button again to enter the Settings Menu.
4. Use the **▲** Up and **▼** Down Buttons to navigate the Settings Menu and highlight the Key Beeps setting and press **OK** (Rec/ Ok) to select.
5. Use the **▲** Up and **▼** Down Buttons to highlight either OFF or ON, then press the **OK** (Rec/Ok) button to confirm your selection.

Note:

- Menus cannot be accessed while the camera is recording. Please stop the recording before attempting to access the menu.





3. PHOTO MODE

This screen is used to capture still images using your Car DVR. To access the Photo screen ensure that the camera is not recording and press the  button. Photo mode also has a menu which is used to edit the photo settings. This menu can be accessed by pressing the  in the Photo Screen.

3.1 PHOTO MENU

RESOLUTION

Resolution sets the still image quality. Higher resolution images will capture more detail and will also produce larger files. To change the photo resolution, please follow the instructions below.



1. Enter the Photo screen.
2. Press the  Button to enter the Photo Menu.
3. Use the  Up and  Down Buttons to navigate the Photo Menu and highlight Resolution setting and press **OK** (Rec/Ok) to select.
4. Use the  Up and  Down Buttons to highlight your required resolution, then press the **OK** (Rec/Ok) button to confirm your selection.

Note:

- Menus cannot be accessed while the camera is recording. Please stop the recording before attempting to access the menu.
- This setting can only be accessed through the Photo Menu, please make sure that you are in the Photo screen when you access the menu.

SEQUENCE

When Sequence is activated, when a photo is triggered a sequence of 3 photos is taken. To activate or deactivate Sequence mode, follow the instructions below





1. Enter the Photo screen.
2. Press the  Button to enter the Photo Menu.
3. Use the  Up and  Down Buttons to navigate the Photo Menu and highlight Sequence setting and press **OK** (Rec/Ok) to select.
4. Use the  Up and  Down Buttons to highlight OFF or ON, then press the **OK** (Rec/Ok) button to confirm your selection.

Note:

- Menus cannot be accessed while the camera is recording. Please stop the recording before attempting to access the menu.
- This setting can only be accessed through the Photo Menu, please make sure that you are in the Photo screen when you access the menu.

QUALITY

Quality sets the image detail. Higher quality images will capture more detail and will also produce larger files. To change the recording resolution, please follow the instructions below.

1. Enter the Photo screen.
2. Press the  Button to enter the Photo Menu.
3. Use the  Up and  Down Buttons to navigate the Photo Menu and highlight the Quality setting and press **OK** (Rec/Ok) to select.
4. Use the  Up and  Down Buttons to highlight your required quality, then press the **OK** (Rec/Ok) button to confirm your selection.

Note:

- Menus cannot be accessed while the camera is recording. Please stop the recording before attempting to access the menu.
- This setting can only be accessed through the Photo Menu, please make sure that you are in the Photo screen when you access the menu.

SHARPNESS

Sharpness sets the boldness of the image. Images with a stronger sharpness will create bolder images with stronger outlines. To change the photo Sharpness, please follow the instructions below.

1. Enter the Photo screen.
2. Press the **≡** Button to enter the Photo Menu.
3. Use the **▲** Up and **▼** Down Buttons to navigate the Photo Menu and highlight the Sharpness setting and press **OK** (Rec/Ok) to select.
4. Use the **▲** Up and **▼** Down Buttons to highlight your required sharpness, then press the **OK** (Rec/Ok) button to confirm your selection.

Note:

- Menus cannot be accessed while the camera is recording. Please stop the recording before attempting to access the menu.
- This setting can only be accessed through the Photo Menu, please make sure that you are in the Photo screen when you access the menu.

WHITE BALANCE

The White Balance setting is used to manually adjust the settings used to counteract different light conditions. This setting is set to Auto by default. To change the White Balance setting follow the instructions below.

1. Enter the Photo screen.
2. Press the **≡** Button to enter the Photo Menu.
3. Use the **▲** Up and **▼** Down Buttons to navigate the Photo Menu and highlight the White Balance setting and press **OK** (Rec/Ok) to select.
4. Use the **▲** Up and **▼** Down Buttons to highlight your required setting, then press the **OK** (Rec/Ok) button to confirm your selection.

Note:

- Menus cannot be accessed while the camera is recording. Please stop the recording before attempting to access the menu.
- This setting can only be accessed through the Photo Menu, please make sure that you are in the Photo screen when you access the menu.

ISO

ISO is used to manage how much light is let into the image sensor. Setting a higher ISO will let in more light and blurred movement and lower ISO will capture less movement and less light. To change the ISO setting follow the instructions below.

1. Enter the Photo screen.
2. Press the **≡** Button to enter the Photo Menu.
3. Use the **▲** Up and **▼** Down Buttons to navigate the Photo Menu and highlight the ISO setting and press **OK** (Rec/Ok) to select.
4. Use the **▲** Up and **▼** Down Buttons to highlight your required ISO setting, then press the **OK** (Rec/Ok) button to confirm your selection.

Note:

- Menus cannot be accessed while the camera is recording. Please stop the recording before attempting to access the menu.
- This setting can only be accessed through the Photo Menu, please make sure that you are in the Photo screen when you access the menu.

EXPOSURE

Exposure is used to manually control the light settings. To change the Exposure setting follow the instructions below

1. Enter the Photo screen.
2. Press the **≡** Button to enter the Photo Menu.
3. Use the **▲** Up and **▼** Down Buttons to navigate the Photo Menu and highlight the Exposure setting and press **OK** (Rec/Ok) to select.
4. Use the **▲** Up and **▼** Down Buttons to highlight your required Exposure setting, then press the **OK** (Rec/Ok) button to confirm your selection.

Note:

- Menus cannot be accessed while the camera is recording. Please stop the recording before attempting to access the menu.
- This setting can only be accessed through the Photo Menu, please make sure that you are in the Photo screen when you access the menu.

QUICK REVIEW

Quick review displays the photo on screen for the set amount of time after the photo has been taken. To change the Quick Review setting follow the instructions below.

1. Enter the Photo screen.
2. Press the **≡** Button to enter the Photo Menu.
3. Use the **▲** Up and **▼** Down Buttons to navigate the Photo Menu and highlight the Quick Review setting and press **OK** (Rec/Ok) to select.
4. Use the **▲** Up and **▼** Down Buttons to highlight your required image display time setting, then press the **OK** (Rec/Ok) button to confirm your selection.

Note:

- Menus cannot be accessed while the camera is recording. Please stop the recording before attempting to access the menu.
- This setting can only be accessed through the Photo Menu, please make sure that you are in the Photo screen when you access the menu.

DATE STAMP

Date stamp is used to stamp your photos with the time and date that they are taken. To select your preferred time and date format follow the instructions below.

1. Enter the Photo screen.
2. Press the **≡** Button to enter the Photo Menu.
3. Use the **▲** Up and **▼** Down Buttons to navigate the Photo Menu and highlight the Date Stamp setting and press **OK** (Rec/Ok) to select.
4. Use the **▲** Up and **▼** Down Buttons to highlight either Date, Date/Time or ON, then press the **OK** (Rec/Ok) button to confirm your selection.

Note:

- Menus cannot be accessed while the camera is recording. Please stop the recording before attempting to access the menu.
- This setting can only be accessed through the Photo Menu, please make sure that you are in the Photo screen when you access the menu.
- The Date Stamp setting is not used to set the cameras internal clock. To set the time follow the instructions Date/Time in the settings section.

FORMATTING THE INSERTED MICRO SD CARD

Formatting the Micro SD card will delete all information on the inserted Micro SD Card and prepare the card for use with the Car DVR.

1. Press the **OK** Rec/Ok Button to stop the Car DVR from recording.
2. Press the **≡** Menu Button to enter the Video Menu.
3. Press the **≡** Menu Button again to enter the Settings Menu.
4. Use the **▲** Up and **▼** Down Buttons to navigate the Settings Menu and highlight the Format setting and press **OK** Rec/Ok to select.
5. Select OK to confirm and press the **OK** Rec/Ok Button.

Note:

- Menus cannot be accessed while the camera is recording. Please stop the recording before attempting to access the menu.
- Formatting your Micro SD Card will delete all files from the card. Once these files have been deleted you will not be able to recover them.

3.2 PLAYBACK SCREEN

This screen is used to playback photos and videos. To access the Playback screen ensure that the camera is not recording and press the **↔** button. This will send the camera to the photo screen. While in the Photo Screen press the **↔** button again which will bring you to the Playback Screen. In this screen the **▲** Up and **▼** Down Buttons are used to cycle through the recorded videos and photos and the **OK** (Rec/Ok) button is used to play and pause videos. While playing a video the **▲** Up and **▼** Down Buttons to adjust the playback speed. In the Playback Screen photos and videos can also be locked and deleted via the Playback Menu. This menu can be accessed by pressing the **≡** in the Photo Screen.

3.3 PLAYBACK MENU

DELETING PHOTOS AND VIDEOS

To delete an unlocked photo or video follow the instructions below.

1. Navigate to the playback screen using the instructions in the section labelled Playback Screen.
2. In the Playback Screen use the **▲** Up and **▼** Down Buttons to select the photo or video that you want to delete (if you want to delete all unlocked photos and videos select any unlocked Photo or Video).
3. Press the **≡** button to enter the Playback Menu and use the **▲** Up and **▼** Down Buttons to select the Delete setting and press the **OK** (Rec/Ok) button.
4. Use the **▲** Up and **▼** Down Buttons to select either Delete all, which will delete all unlocked photos and videos, or Delete Current which will delete the selected photo or video.
5. Select OK and press the **OK** (Rec/Ok) button to confirm the deletion.

Note:

- Menus cannot be accessed while the camera is recording. Please stop the recording before attempting to access the menu.
- You will only be able to delete videos that have not been protected by a G Sensor.
- To unlock protected files please follow the directions in the section marked Protect Photos and Videos.
- To easily delete all files on the inserted Micro SD Card, please follow the instructions given in the section marked Format

LOCKING AND UNLOCKING PHOTOS AND VIDEOS

To Lock or Unlock photos or videos from being deleted, please follow the instructions below.

1. Navigate to the playback screen using the instructions in the section labelled Playback Screen.
2. In the Playback Screen use the ▲ Up and ▼ Down Buttons to select the photo or video that you want to lock or unlock (if you want to lock or unlock all photos and videos select any Photo or Video).
3. Press the ≡ button to enter the Playback Menu and use the ▲ Up and ▼ Down Buttons to select the Protect setting and press the **OK** (Rec/Ok) button.
4. Use the ▲ Up and ▼ Down Buttons to select either Unlock All, which will unlock all photos and videos, Unlock Current to unlock the currently selected photo or video, Lock All to lock all videos and photos to protect them from deletion, or Lock Current to lock the currently selected to protect the currently selected photo or video from deletion.
5. Select OK and press the **OK** (Rec/Ok) button to confirm your selection.

Note:

- Menus cannot be accessed while the camera is recording. Please stop the recording before attempting to access the menu.
- To easily delete all file on the inserted Micro SD Card, please follow the instructions given in the section marked Format.

4. MENU TABLES

Video	Resolution	1080FHD 1920x1080	
		1080P 1440x1080	
		720P 1280x720	
		WVGA 848x480	
		VGA 640x480	
	Loop recording	Off	3 Minutes
		1 Minutes	5 Minutes
		2 Minutes	10 Minutes
	Exposure	+2.0	-1/3
		+5/3	-2/3
		+4/3	-1.0
		+1.0	-4/3
		+2/3	-5/3
+1/3		-2.0	
	+0.0		
Motion Detection	Off	On	
Recording Audio	Off	On	
Date Stamp	Off	On	
G Sensor	Off	4G	
		2G 8G	

Photo	Resolution	12M 4032x3024	
		10M 3648x2736	
		8M 2364x2448	
		5M 2592x1944	
		3M 2048x1536	
		2MHD 1920x1080	
		1.3M 1280x960	
		VGA 640x480	
	Sequence	Off	On
	Quality	Fine	Economic
		Normal	
	Sharpness	Strong	
		Normal	
Soft			
White Balance	Auto	Tungsten	
	Daylight	Fluorescent	
	Cloudy		
ISO	Auto		
	100		
	200		

Photo	Exposure	+2.0	-1/3
		+5/3	-2/3
		+4/3	-1.0
		+1.0	-4/3
		+2/3	-5/3
		+1/3	-2.0
		+0.0	
	Anti Shaking	Off	On
	Quick Review	Off	On
	Date Stamp	Off	Date
		Date/Time	

MENU TABLES CONTINUED

Settings	Resolution	OFF	
		2G	
		4G	
		8G	
	Date/Time	Set Date and Time	
	Auto Power Off	Off	3 Minutes
		1 Minutes	
	Screen Saver	Off	
		3 Minutes	
		5 Minutes	
		10 Minutes	
	Beep Sound	Off	On
Language	Language Select		
Frequency	50Hz	60Hz	
Format	Format Inserted SD Card		
Default Setting	Revert to Default		
Version	Display Version Number		

Playback	Delete	Delete Current
		Delete All
	Protect	Lock Current
		Unlock Current
		Lock All
		Unlock All

5. WARRANTY TERMS & CONDITIONS

Our goods come with guarantees that cannot be excluded under the Australian & New Zealand Consumer Law. You are entitled to a replacement or refund for a major failure and for compensation for any other reasonably foreseeable loss or damage. You are also entitled to have the goods repaired or replaced if the goods fail to be of acceptable quality and the failure does not amount to a major failure.

This warranty is provided in addition to your rights under the Australian & New Zealand Consumer Law.

NanoCam Plus warrants that this product is free from defects in material and workmanship for a period of 12 months from the date of purchase or for the period stated on the packaging. This warranty is only valid where you have used the product in accordance with any recommendations or instructions provided by NanoCam Plus.

This warranty excludes defects resulting from alterations of the product, accident, misuse, abuse or neglect.

In order to claim the warranty, you must return the product to the retailer from which it was purchased or if that retailer is part of a National network, a store within that chain, along with satisfactory proof of purchase. The retailer will then return the goods to NanoCam Plus.

NanoCam Plus will repair, replace or refurbish the product at its discretion. The retailer will contact you when the product is ready for collection. All costs involved in claiming this warranty, including the cost of the retailer sending the product to NanoCam Plus, will be borne by you.

NanoCam Plus Address: 44 Translink Drive, Keilor Park Victoria Australia 3042

Ph: +61 03 8331 4800

Email: info@nanocamplus.com.au

6. NOTES

Your Safety, *Our Priority*

NANO
CAM PLUS

www.nanocamplus.com.au
www.nanocamplus.co.nz

CE FC



ROHS



EXCLUSIVE TO
SUPERCHEAP
AUTO